

paco[®]

CONVERTS 12 VOLT DC INTO AC POWER

POWER INVERTER

AC POWER APPLIANCES FROM A 12 VOLT BATTERY

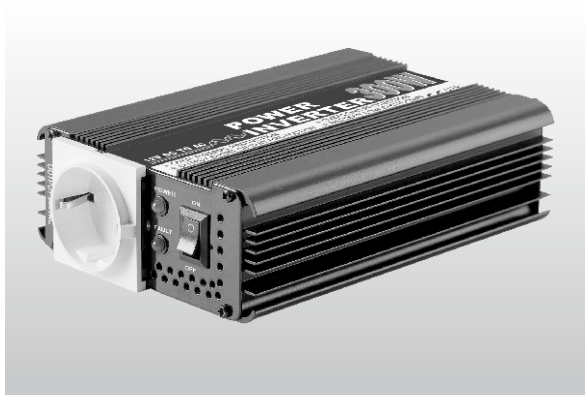

12 VOLT DC TO AC INSTRUCTION MANUAL

Please read user manual before use.



USEFUL APPLICATIONS

RUN NOTEBOOK COMPUTERS, RADIOS, TVS, VCRS, LAMPS, FANS, FAX, DRILL, ETC.

1. DESCRIPTION

FIG 1

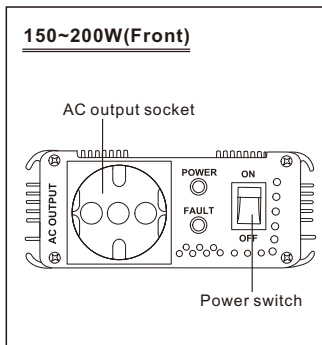
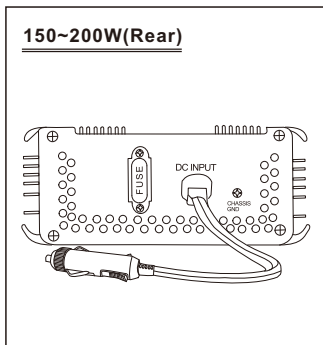

FIG 2

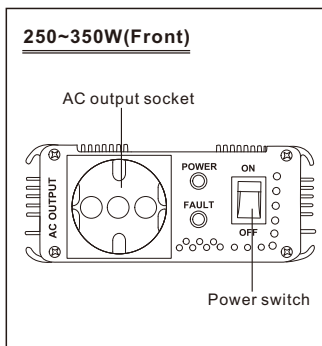
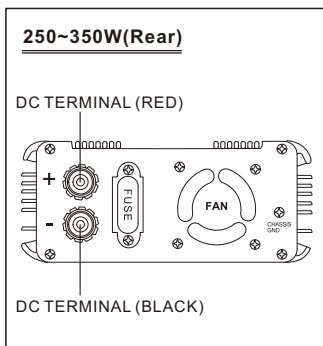

FIG 3

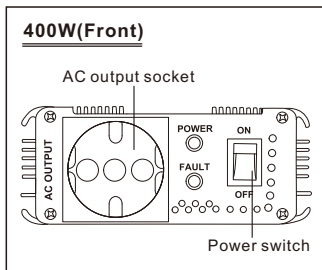
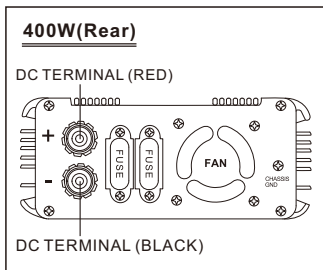

FIG 4

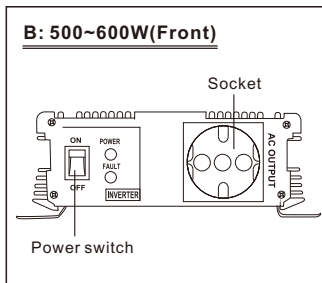
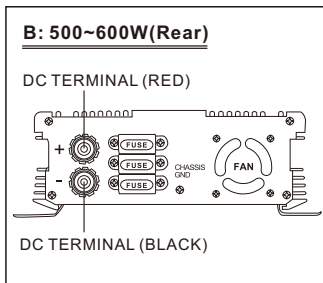
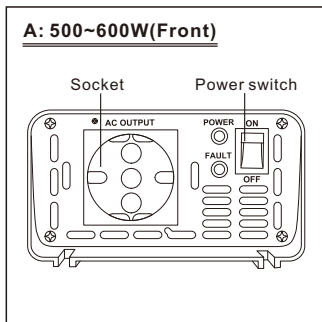
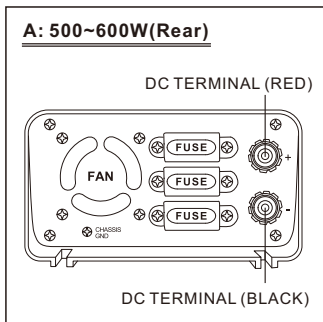

FIG 5

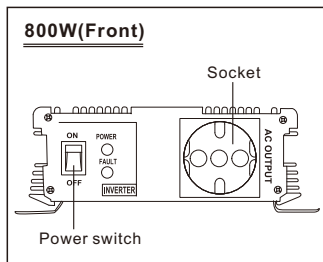
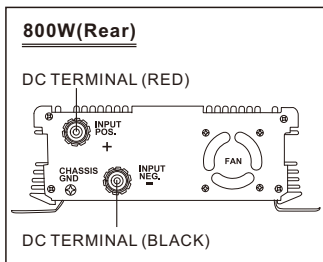

FIG 6

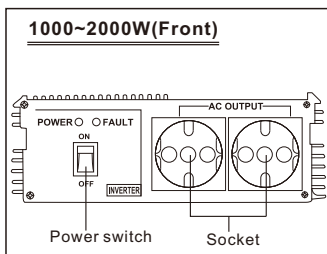
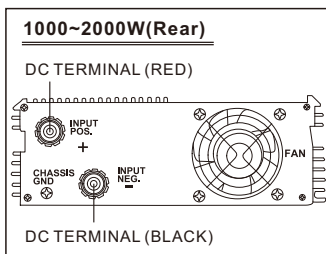

FIG 7

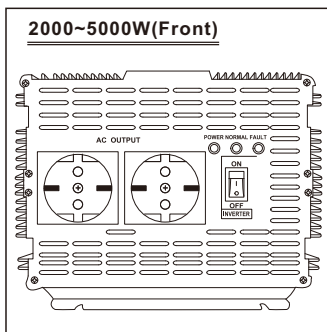
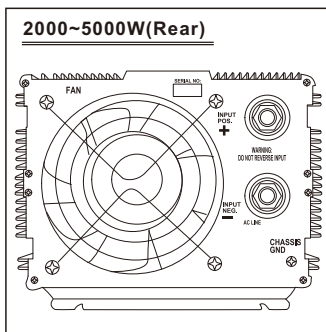
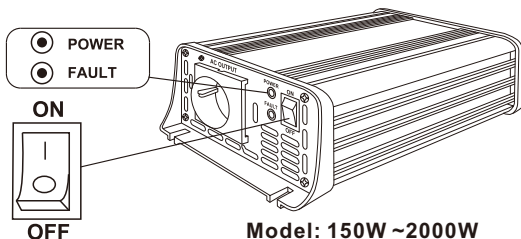

FIG 8

INDICATING SIGN

GREEN LIGHTED LED: POWER SWITCH "ON" , INVERTER STANDBY
GREEN UNLIGHTED LED: POWER SWITCH "OFF"
WHEN RED LIGHTED ON: IT MEANS THE POWER INVERTER IS AT FAULT



POWER GREEN LIGHTED LED: POWER SWITCH"ON" INVERTER STANDBY
NORMAL GREEN LIGHTED LED: IT MEANS THE POWER INVERTER IS WORKING NORMALLY
WHEN RED LIGHTED ON : IT MEANS THE POWER INVERTER IS AT FAULT

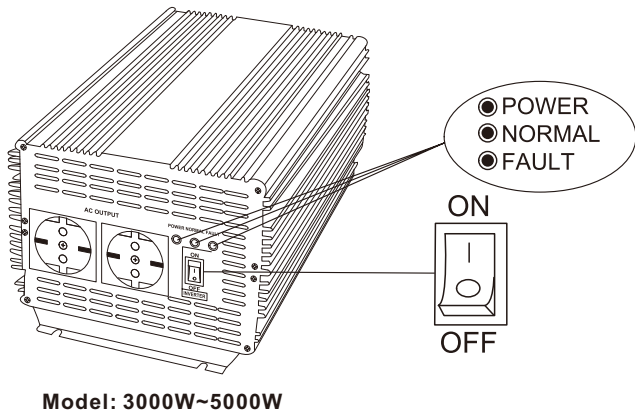

2. ACCESSORY

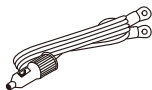

DC cable with cigarette lighter plug

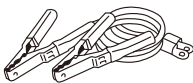

DC cable clips



DC cable clips

3. CONNECTION

Connect to lighter for appliances 0-200W or connect directly to battery (clips included) for appliances of 200-2000W.

Please verify if you have chosen the right operating voltage for both input and output.

Connect the red cable from the "+" terminal (red terminal) of the battery to the + binding post (red connection) of the inverter and the black cable from the "-" terminal (black terminal) of the battery to the "-" binding post (black connection) of the inverter.

Be sure to right the screws in order to avoid loose connection.

4. OPERATION

- A) When connected to an appliance, remember to turn on the inverter before turning on the appliance. If the buzzer sounds during operation, this indicates that the battery voltage is very low and the inverter will be disconnected in 5 minutes.

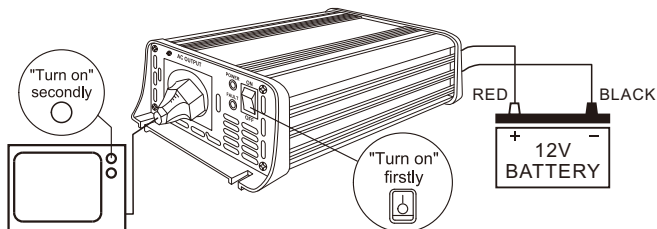

Model: 150W ~2000W

- B) When connect the electrical appliance that with CRT,such as TV set, computer and so on to the Power Inverter which below 500W, the electrical appliance may be started for several times before it can work smoothly. Don't start the power inverter when it is with loaded, otherwise the power inverter will be damaged.

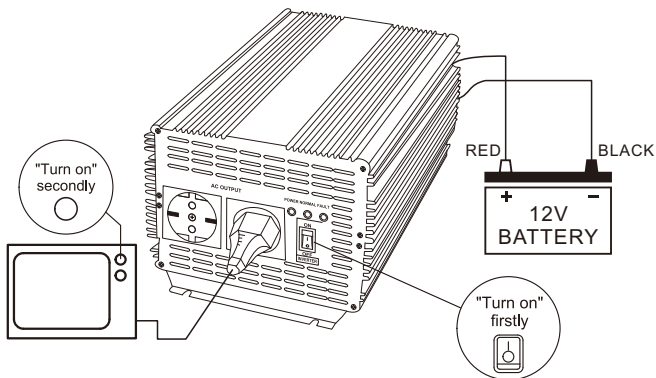

Model: 3000W~5000W

- C) When connect the electrical appliance that with motor or compressor, such as drill, air-condition and so on to the power inverter, please make sure that the power rating of the power inverter is at least 3 times of the power rating of the electrical appliance, so that it can work smoothly, because the starting up power is much beyond of the power rating of the electrical appliance.

5. OUTPUT CAPACITY

The inverter will switch off automatically if the total wattage of the electrical appliances exceeds the inverter's output capacity. This will also happen if the temperature of the inverter exceeds 60°C due to prolonged use.

6. SPECIAL RECOMMENDATION

Unplug the AC inverter when not in use.

Unplug the AC inverter when starting the vehicle's motor.

If the AC inverter makes a beeping sound: switch off your appliance, unplug the inverter and restart your vehicle's the engine. The beeping sound is simply the low-battery warning which indicates that the voltage of your battery is getting low. Your inverter will shut down automatically if you do not restart your engine and continue the use of your inverter. This will leave your vehicle's battery at about 10.5VDC (21VDC when using 24V inverter / 42VDC when using 48V inverter), enabling you to start your engine and resume operation of the inverter. It also eliminates the possibility of being stranded with a dead battery.

To avoid over-discharging the battery, it is advisable to let your engine run for 10 to 20 minutes after every 2-3 hours of using the AC inverter. This allows your vehicle's battery to recharge.

Please remember to connect the "+" wire to the "+" terminal and the "-" wire to the "-" terminal if you choose to use an adapter in order to establish a direct connection between the AC inverter and the battery terminals. **IF YOU CONNECT THE WIRES TO INCORRECT TERMINALS, THE POLARITY WILL BE REVERSED AND THIS WILL DAMAGE THE INVERTER. REVERSED POLARITY WILL INSTANTLY VOID YOUR INVERTER'S WARRANTY.**

Please remember to disconnect the AC inverter before using the battery charger to replenish you battery's voltage. Failure to disconnect the inverter prior to connecting a charger may result in an input spike which will damage the inverter. **CONNECTING THE INVERTER'S INPUT TO A BATTERY CHARGER WILL VOID THE WARRANTY AND MAY DAMAGE THE INVERTER**

Make sure that the battery's voltage never exceeds 15VDC (30VDC when 24V version is used / 60VDC when 48V version is used). **CONNECTING THE INVERTER TO A DC POWER SOURCE GREATER THAN 15VDC (NO MORE THAN 30V WHEN YOU ARE USING 24V INVERTER / NO MORE THAN 60V WHEN YOU ARE USING 48V INVERTER). WILL VOID THE WARRANTY AND MAY DAMAGE THE INVERTER.**

7. ADDING EXTENSION CORD

We recommend that the buyer refrain from using an extension cord between the DC power source and the inverter's DC input. Connecting an extension cord to the DC input will create a voltage drop, entailing reduced efficiency and output. Instead, we recommend the use of an extension cord between the AC output and the AC appliance. You may use up to 100ft (30m) of high quality extension cord. A longer cord may result in reduced power.

8. GROUNDING CONNECTION

WARNING: BEFORE USING THIS INVERTER YOU MUST PROVIDE A GROUND CONNECTION TO THE INVERTER.

- On the rear panel of the Inverter is a terminal fitted with a nut. This terminal is connected to the case of the Inverter and also to the earth terminal of the AC output socket. The use of this terminal will depend on your particular installation. In any installation, heavy duty, green-insulated wire should be used for this connection.
- In a stationary land based installation, the earth terminal should be connected to a metal earthing stake driven into the ground to a depth of 1.2m or more. If the battery system powering the Inverter does not have a connection to ground, one of the battery terminals (commonly the negative terminal) should also be connected to the earthing stake.
- In a vehicle where the Inverter is wired directly to the battery, the earth terminal is simply connected to the vehicle chassis. If the Inverter is to be used in a vehicle on a temporary basis and will be powered via the cigarette lighter socket in the vehicle, the earth terminal should be connected via a short link to either the negative or positive DC input terminal of the Inverter, depending on whether the vehicle has a negative or positive chassis connection. However when using the Inverter to power equipment used outside the vehicle, an earthing stake should also be used, as described above.
- In a boat, the grounding terminal should be connected to the existing grounding system, which may be the hull of the craft, or a network of ground wires.

NOTE: The grounding terminal of the AC outlet is connected to the neutral terminal. This is the same as a standard household power point where the neutral line is bonded to grounding and there is normally no voltage between them.

9. MEASURING AC VOLTAGE

The output wave of the AC inverter is a MODIFIED SINEWAVE. If you choose to measure the AC output voltage, you must use an AUTHENTIC RMS VOLT METER. Using any other type of voltage measuring device will result in an AC voltage reading that is up to 20 to 30 volts lower than the rated value. The reading will only be accurate when using an authentic RMS voltmeter.

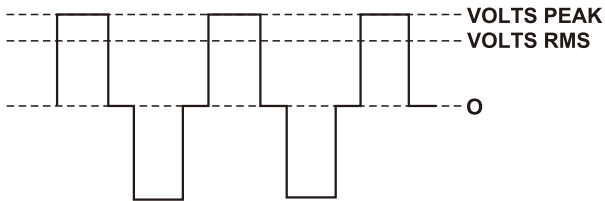
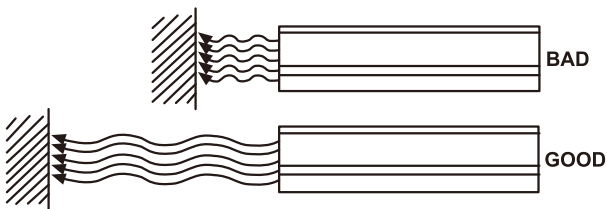

FIGURE 1: D/A INVERTER-MODIFIED SINEWAVE

10. VENTILATION

IMPORTANT! During operation, make sure the fan keeps revolving. Check the inverter for possible malfunctions if the fan does not work when this unit is being used.

Make sure the fan is not blocked in order to avoid poor ventilation.



11. CHASSIS EARTHING

The chassis earthing lug should be connected to an earthing point, which will vary depending on where the power inverter is installed. In a vehicle, connect the chassis ground lug to the chassis of the vehicle. In a boat, connect to the boat's grounding systems. In a fixed location, connect to grounding.

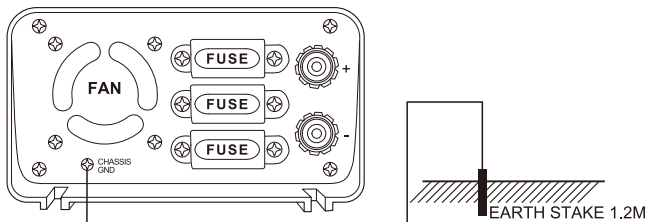

Model: 150W ~2000W

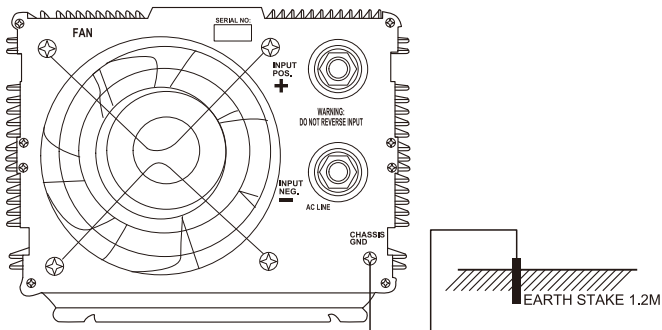

Model: 3000W~5000W

12. CAUTION

In case of trouble with the AC output, e.g. short-circuit, overload, etc... the protection circuit will automatically cut off the output.

In such cases:

- (A) switch off the power at once
- (B) disconnect all units
- (C) check the connected devices
- (D) use the units again as soon as any problems concerning the connected devices have been solved

When in use for a prolonged period of time, the AC output may suddenly be cut off although the battery voltage is still very strong. This may be caused by excessive temperatures. If this happens, please proceed as follows:

- (A) Switch off the inverter at once
- (B) Disconnect some of the appliances or wait until the inverter cools off
- (C) Switch the inverter back on

Always keep the inverter in an environment which is:

- (A) Well-ventilated
- (B) Not exposed to direct sunlight or any other heat source
- (C) Inaccessible to children
- (D) Safe from water/moisture, oil or grease
- (E) Safe from any flammable substance

If the inverter is connected in the wrong way, this will void the warranty.

13. MAINTENANCE

Very little maintenance is required to keep your Inverter operating properly. You should clean the exterior of the unit periodically with a damp cloth to prevent accumulation of dust and dirt. At the same time, tighten the screws on the DC input terminals.

14. NOTE

All specifications typical at nominal line, half load, and 25°C unless otherwise noted. Specifications subject to change without notice.

**WARNING: DO NOT DISASSEMBLY THE UNIT. HAZARDOUS VOLTAGE!
DANGER!**

PLEASE RETURN TO THE DEALER IF YOU FIND ANY PROBLEM WITH THE UNIT.

15.SUITABLE POWER SOURCE:

In order to operate the inverter and supply power to an appliance a suitable 12V DC power supply is required. This can be a vehicle or caravan battery, portable power pack or an independent 12V lead acid battery, For most applications, a deep cycle battery is recommended for best performance..

The size of the battery used will determine how long the inverter will supply power to an appliance and how well the inverter will perform. Most batteries are marked with their size in Amp hours (AH) or Cold Cranking Amps.

Because 12 Volt inverters are capable of drawing high currents the inverter should only be connected to a suitable size battery, Connection to an undersized battery could damage the battery and will result in the inverter shutting down within a short period due to low battery voltage.

The amount of power down from the battery is proportional to the inverter load.

P/No.	150W	200W	250W	300W	350W	400W
Minimum Recommended Battery Size	17Ah	24Ah	24Ah	24Ah	50Ah	50Ah
Run time with maximum load & minimum battery size	40min	53min	46min	40min	45min	40min
Run time for a 100 Watt globe with minimum battery size	80min	2 hours	2 hours	2 hours	4 hours	4 hours
Ideal battery size	50-70Ah	50-70Ah	50-70Ah	50-70Ah	50-100Ah	50-100Ah

P/No.	500W	600W	800W	1000W	1200W	1500W
Minimum Recommended Battery Size	50Ah	50Ah	75Ah	75Ah	75Ah	85Ah
Run time with maximum load & minimum battery size	35min	30min	20min	15min	10min	7min
Run time for a 100 Watt globe with minimum battery size	4 hours	4hours	6 hours	6 hours	6 hours	7 hours
Ideal battery size	50-130Ah	50-130Ah	75-250Ah	75-250Ah	75-300Ah	85-400Ah

P/No.	2000W	3000W	4000W	5000W
Minimum Recommended Battery Size	85Ah	100Ah	150Ah	200Ah
Run time with maximum load & minimum battery size	5min	Not Recommended	Not Recommended	Not Recommended
Run time for a 100 Watt globe with minimum battery size	7 hours	8 hours	12 hours	16 hours
Ideal battery size	85-400Ah	100-500Ah	150-600Ah	200-700Ah

16.DETERMINING SUITABLE LOAD / APPLIANCES

The inverter is fitted with 1 to 2 approved EUROPEAN sockets (depending on model) either or both sockets can be used. As long as the combined load (Watts required to run appliance) does not exceed the inverter's continuous rating. All appliances have a rating plate that shows the amount of power (Watts) used or the current (Amp) drawn under normal use. The following table shows the maximum combined AC Amp Watts or AC Amp which can be run by the inverter.

P/No.	150W	175W	200W	250W	300W
AC combined max load (Watts)	150W	175W	200W	250W	300W
AC combined max load (Amps)	0.65A	0.76A	0.87A	1.09A	1.3A
Number of sockets	1	1	1	1	1

P/No.	350W	400W	PS500-12	PS600-12
AC combined max load (Watts)	350W	400W	500W	600W
AC combined max load (Amps)	1.52A	1.74A	2.2A	2.7A
Number of sockets	1	1	1	1

P/No.	800W	1000W	1200W	1500W
AC combined max load (Watts)	800W	1000W	1200W	1500W
AC combined max load (Amps)	3.5A	4.4A	5.3A	6.5A
Number of sockets	1	2	2	2

P/No.	2000W	3000W	4000W	5000W
AC combined max load (Watts)	3000W	3000W	4000W	5000W
AC combined max load (Amps)	8.7A	13.1A	17.4A	21.8A
Number of sockets	2	2	2	2

Note: For 4000W & 5000W do not exceed 3500W (16Amp) per socket outlet.

Some appliances that use an electric motor or transformer may draw 2 to 6 times their rating when first turned on. these are called inductive loads and are the most difficult for the inverter to run.

For these appliances it is often a matter of trial and error to see what size inverter they will run on. if in doubt always use a larger inverter. The following table is a guide to the appropriate AC Watt drawn by various appliances. The DC Amp column shows the approximate power drawn from the 12 Volt supply.

APPLICATION CHART		Approximate	
Appliance		AC Watts	DC Amps
Small Air Compressor*/Water Heater		5000	470
Small Air Compressor*/Water Heater		4000	380
Larger Power Tools*/Electric Kettle		3000	260
Circular Power Saw/Electric Chainsaw		2000	175
Toaster/Sandwich Maker		1500	140
Small Household Vacuum Cleaner		1250	95
Belt Sander & other Power Tools		1000	92
Small Microwave Oven (500/600W)*		900	83
Combo TV/VCR		750	69
Power Drill/Portable Grinder		600	50
Flood Lights (500W)		500	46
Submersible Pump*		400	37
Small Colour Television*		350	32
Small Power Tools/Fluorescent Light*		300	28
Juicer/Blender		250	23
Bar Fridge*/Large Stereo/PA Amplifier		200	19
Hand Mixer		175	16
Laptop Computer/Electric Knife		150	12
Portable Stereo/CD/DVD/VCR/Playstation		100	9
Charger/Mobile Phone/Camera/Camcorder		50	5

※ Appliance may require larger inverter.

17. HARD WIRED CONNECTION

When mounting the inverter in a vehicle, boat or cabin it may be preferable to use longer DC battery cables than those supplied, so that the inverter can be placed in a more convenient cooler or more protected location.

POWER INVERTER SPECIFICATION

IDEAL \ Model	150W	175W	200W	250W	300W
Nominal Input Voltage (DC)	12V \pm , 13.7A	12V \pm , 16A	12V \pm , 18A	12V \pm , 22.8A	12V \pm , 27.5A
Nominal Input Voltage Range (DC)	12V \pm (10-15V)				
Output Power (Continuous Watts)	150W, 0.65A	175W, 0.76A	200W, 0.87A	250W, 1.09A	300W, 1.3A
Output Power (Peak Watts) For 0.5 sec	300W	350W	400W	500W	600W
Standby Current	\leq 0.21A	\leq 0.21A	\leq 0.25A	\leq 0.32A	\leq 0.35A
Nominal Output Voltage (AC)	<input type="checkbox"/> 230V \sim <input type="checkbox"/> 220-240V \sim <input type="checkbox"/> 110V \sim				
Frequency	<input type="checkbox"/> 50Hz <input type="checkbox"/> 60Hz +/-5% Crystal Controlled				
Output Regulation	+/-5% Intelligent Pwm				
Output Waveform	Modified Sine Wave				
Low Battery-Voltage Alarm (Volts)	10.5 +/-0.5V \pm				
Low Battery-Voltage Shutdown (Volts)	10 +/-0.5V \pm				
Efficiency	85~90%				
Thermal Protection	65°C +/-5 °C				
Overload	Shut Down & Alarm				
Battery Polarity Reverse	By Fuse				
Output Short	Output Short Circuit Protection				
With Cooling Fan	No	No	No	Yes	Yes
AC Outlets Socket	1	1	1	1	1
Replaceable Fuse	20A	20A	25A	30A	40A
Dimension (L \times W \times H) cm	15x12.5x5.2	15x12.5x5.2	15x12.5x5.2	15x12.5x5.2	15x12.5x5.2
Weight	0.55Kg	0.7Kg	0.7Kg	0.71Kg	0.75Kg

* DC input voltage must be + 12V DC

AC Output Socket:

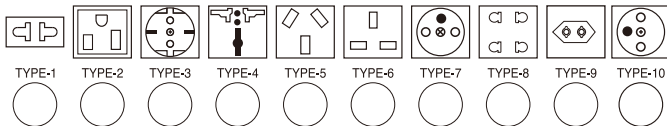

POWER INVERTER SPECIFICATION

IDEAL	Model					
	350W	400W	500W	PS500-12	600W	PS600-12
Nominal Input Voltage (DC)	12V \pm , 32A	12V \pm , 36.5A	12V \pm , 45.5A	12V \pm , 45.5A	12V \pm , 55A	12V \pm , 55A
Nominal Input Voltage Range (DC)	12V \pm (10-15V)					
Output Power (Continuous Watts)	350W, 1.52A	400W, 1.74A	500W, 2.2A	500W, 2.2A	600W, 2.7A	600W, 2.7A
Output Power (Peak Watts) For 0.5 sec	700W	800W	1000W	1000W	1200W	1200W
Standby Current	\leq 0.35A	\leq 0.35A	\leq 0.5A	\leq 0.5A	\leq 0.5A	\leq 0.5A
Nominal Output Voltage (AC)	<input type="checkbox"/> 230V \sim <input type="checkbox"/> 220-240V \sim <input type="checkbox"/> 110V \sim					
Frequency	<input type="checkbox"/> 50Hz <input type="checkbox"/> 60Hz +/-5% Crystal Controlled					
Output Regulation	+/-5% Intelligent Pwm					
Output Waveform	Modified Sine Wave					
Low Battery-Voltage Alarm (Volts)	10.5+/-0.5V \pm					
Low Battery-Voltage Shutdown (Volts)	10+/-0.5V \pm					
Efficiency	85~90%					
Thermal Protection	65°C+/-5 °C					
Overload	Shut Down & Alarm					
Battery Polarity Reverse	By Fuse					
Output Short	Output Short Circuit Protection					
With Cooling Fan	Yes Auto-operation fan (temperature or load)					
AC Outlets Socket	1	1	1	1	1	1
Replaceable Fuse	40A	2x25A	3x20A	3x20A	3x25A	3x25A
Dimension (L×W×H) cm	17x12.5x5.2	17x12.5x5.2	15.5x16.4x6.2	19x11.1x5.5	15.5x16.4x6.2	19x11.1x5.5
Weight	0.76Kg	0.87Kg	1.4Kg	1.7Kg	1.5Kg	1.75Kg

* DC input voltage must be + 12V DC

AC Output Socket:

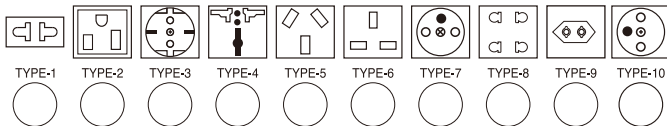

POWER INVERTER SPECIFICATION

IDEAL \ Model	800W	1000W	1200W	1500W	2000W
Nominal Input Voltage (DC)	12V $\overline{=}$, 73A	12V $\overline{=}$, 91A	12V $\overline{=}$, 110A	12V $\overline{=}$, 137A	12V $\overline{=}$, 183A
Nominal Input Voltage Range (DC)	12V $\overline{=}$ (10-15V)				
Output Power (Continuous Watts)	800W, 3.5A	1000W, 4.4A	1200W, 5.3A	1500W, 6.5A	2000W, 8.7A
Output Power (Peak Watts) For 0.5 sec	1600W	2000W	2400W	3000W	4000W
Standby Current	$\leq 0.6A$	$\leq 0.6A$	$\leq 0.6A$	$\leq 0.7A$	$\leq 0.7A$
Nominal Output Voltage (AC)	<input type="checkbox"/> 230V \sim	<input type="checkbox"/> 220-240V \sim	<input type="checkbox"/> 110V \sim		
Frequency	<input type="checkbox"/> 50Hz	<input type="checkbox"/> 60Hz +/-5% Crystal Controlled			
Output Regulation	+/-5% Intelligent Pwm				
Output Waveform	Modified Sine Wave				
Low Battery-Voltage Alarm (Volts)	10.5 +/-0.5V $\overline{=}$				
Low Battery-Voltage Shutdown (Volts)	10 +/-0.5V $\overline{=}$				
Efficiency	85~90%				
Thermal Protection	65°C +/-5 °C				
Overload	Shut Down & Alarm				
Battery Polarity Reverse	By Fuse				
Output Short	Output Short Circuit Protection				
With Cooling Fan	Yes Auto-operation fan (temperature or load)				
AC Outlets Socket	1	U.S.A Type: 2AC Outlets/European type: 2AC Outlets			
Replaceable Fuse	4x25A	6x20A	6x25A	9x20A	12x25A
Dimension (L x W x H) cm	26x16.4x6.2	26x19.8x7	26x19.8x7	32x19.8x7	43x19.8x7
Weight	2.3Kg	2.9Kg	3.2Kg	4.3Kg	5.2Kg

* DC input voltage must be + 12V DC

AC Output Socket:

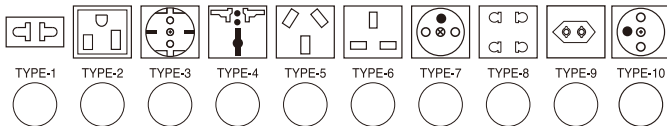

POWER INVERTER SPECIFICATION

IDEAL \ Model	3000W	4000W	5000W	
Nominal Input Voltage (DC)	12V $\overline{=}$, 275A	12V $\overline{=}$, 366A	12V $\overline{=}$, 458A	
Nominal Input Voltage Range (DC)	12V $\overline{=}$ (10-15V)			
Output Power (Continuous Watts)	3000W, 13.1A	4000W, 17.4A	5000W, 21.7A	
Output Power (Peak Watts) For 0.5 sec	6000W	8000W	10000W	
Standby Current	\leq 0.6A	\leq 0.7A	\leq 0.8A	
Nominal Output Voltage (AC)	<input type="checkbox"/> 230V \sim	<input type="checkbox"/> 220-240V \sim	<input type="checkbox"/> 110V \sim	
Frequency	<input type="checkbox"/> 50Hz	<input type="checkbox"/> 60Hz	+/-5% Crystal Controlled	
Output Regulation	+/-5% Intelligent Pwm			
Output Waveform	Modified Sine Wave			
Low Battery-Voltage Alarm (Volts)	10.5+/-0.5V $\overline{=}$			
Low Battery-Voltage Shutdown (Volts)	10+/-0.5V $\overline{=}$			
Efficiency	85~90%			
Thermal Protection	65°C +/-5 °C			
Overload	Shut Down & Alarm			
Battery Polarity Reverse	By Fuse			
Output Short	Output Short Circuit Protection			
With Cooling Fan	Yes Auto-operation fan (temperature or load)			
AC Outlets Socket	U.S.A Type: 4AC Outlets/European type: 2AC Outlets			
Replaceable Fuse	18x25A	24x25A	30x25A	
Dimension (L×W×H) cm	32x21x15.5	38.5x21x15.5	46x21x15.5	
Weight	7.3Kg	8.0Kg	8.7Kg	

* DC input voltage must be + 12V DC

AC Output Socket:

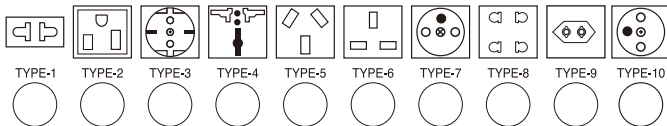

WITH THIS "INVERTER" YOU WON'T HAVE TO WORRY ABOUT POWER OUTAGES OR BROWNOUTS!



WARNING:

To prevent fire or shock hazard do not expose this appliance to rain or moisture

"Please place the inverter used in the horizontal position"

CAUTION:

ALWAYS PLACE THE INVERTER IN AN ENVIRONMENT WHICH IS:

- (A) WELL VENTILATED.
- (B) NOT EXPOSED TO DIRECT SUNLIGHT OR HEAT SOURCE.
- (C) OUT OF REACH FROM CHILDREN.
- (D) AWAY FROM WATER/MOISTURE, OIL OR GREASE.
- (E) AWAY FROM ANY FLAMMABLE SUBSTANCE
- (F) SECURE AND NO RISK OF FALLING.

